

PART NUMBER: CS-3624

DESCRIPTION: solid state buzzer

SPECIFICATONS

operating voltage	20 ~ 28 V DC	
current consumption	24 mA max.	at 24 V DC
sound pressure level	76 db min.	at 30 cm/24 V DC
tone	continuous	
operating temperature	-20 ~ +60° C	
storage temperature	-30 ~ +70° C	
weight	9.7 g max.	
RoHS	yes	

APPEARANCE DRAWING

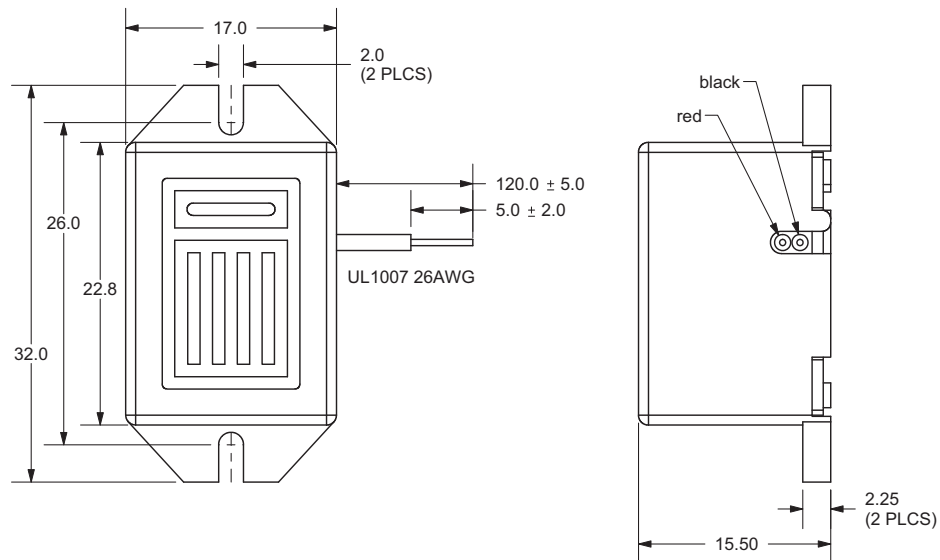
 tolerance: ± 0.5
 units: mm

CURRENT CONSUMPTION/SOUND PRESSURE LEVEL
